

SXPJ SERIES

HID Lighting for Explosion Proof, Hazardous and Hostile Locations

- Class I, Division 1, Group C & D
- Class II, Division 1, Groups E, F & G
- Class III
- Zone 1, Groups IIA & IIB
- Factory Sealed
- NEMA 4X, IP66
- UL 844 & UL 1598A
- CUL



713.943.0340 | azz.com/rigalite

SXPJ SERIES

HID & Fluorescent Lighting for Hazardous and Hostile Locations

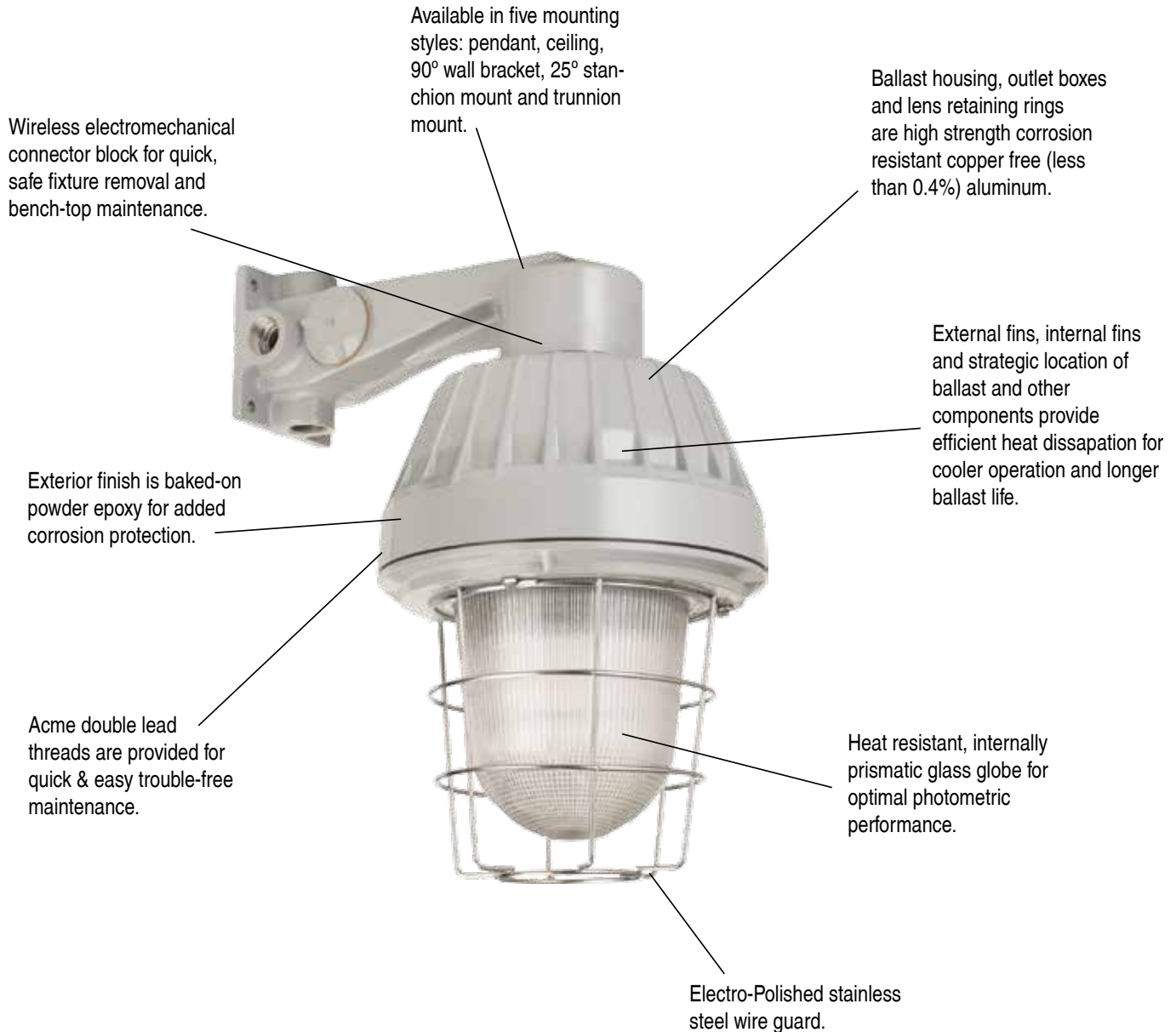

- Factory sealed— external seals not necessary
- Fiberglass reinforced polymeric and aluminum reflectors are available as accessories

SXPJ Series

Explosion Proof • UL 844, & 1598A • Marine Outside Type • Factory Sealed

Catalog Number Logic

SXPJ 15-S-04-GG-P-XX

1

2

3

4

5

6

7

1

BASIC SERIES

Class I, Division 1, Groups C & D
 Class II, Division 1, Groups E, F & G*
 Class III
 Class I, Zone 1, Groups IIA & IIB
 Factory Sealed
 UL1598, UL1598A, & UL844
 CUL
 NEMA Type 4X, IP66

2

LAMP CURRENT/LAMP WATTAGE

26 = 26 Watt
 32 = 32 Watt
 42 = 42 Watt
 50 = 50 Watt
 52 = 52 Watt
 64 = 64 Watt
 07 = 70 Watt
 84 = 84 Watt
 10 = 100 Watt
 15 = 150 Watt
 17 = 175 Watt

3

LAMP TYPE

H = Metal Halide (Medium Base)
 (50, 70, 100, 150 & 175 Watt)
 S = High Pressure Sodium (Medium Base)
 (50, 70, 100 & 150 Watt)
 F = Compact Fluorescent
 (26, 32, 42, 52, 64 & 84 Watt)

4

BALLAST VOLTAGE

04 = 120/208/240/277V 60HZ
 22 = 220V/240V 50HZ
 48 = 480V 60HZ
 U = 120 thru 277V 50/60HZ
 (compact fluorescent)

5

GLOBE & GUARD

GG = Globe and Guard
 G = Globe only

6

MOUNTING STYLE

P = 3/4" Pendant Mount
 P1 = 1" Pendant Mount
 C = 3/4" Ceiling Mount
 C1 = 1" Ceiling Mount
 W = 3/4" Wall Mount
 W1 = 1" Wall Mount
 S = 1-1/4" Stanchion Mount
 S1 = 1-1/2" Stanchion Mount
 T = Trunnion Mount*

7

OPTIONS¹

FB1 = Single Fuse Block ^{2 3}
 FB2 = Double Fuse Block ^{2 3}
 EM = Emergency Battery Backup
 w/ AC Ballast (CFL Only)⁴
 EMO = Emergency Only Battery
 Backup w/o AC Ballast
 (CFL Only)⁴
 PS = Pulse Start (for 150 & 175W MH Lamps)
 BP = Ballast Protector
 SC = Safety Cable & Eye Bolt
 EB = Eye Bolt Only

¹ Consult factory for pricing.

² Not available with multi-tap ballast unless voltage is specified. When installed, one fuse block is provided for 120,277V and two fuse blocks are provided for 208, 220, 240 & 480V. Fuse not included.

³ Fuse option not available for marine listed fixtures.

⁴ For non-switched circuits only.

* Trunnion mount not approved for use in Class II environments

Catalog logic is for explaining catalog number structure only. Not all combinations are possible; consult factory for catalog numbers not listed in charts.

HID • COMPACT FLUORESCENT

SXPJ Series

Explosion Proof • UL 844 & 1598A • Marine Outside Type • Factory Sealed

Certification Guide

MODEL	TYPE (*)	LAMP WATTS	MOUNT	AMBIENT TEMPERATURE °C	CLASS I DIVISION 1 GROUPS C & D	CLASS I ZONE 1 GROUPS IIA & IIB	CLASS II DIVISION 1 GROUPS E, F & G, CLASS III	SUPPLY WIRE SUITABLE TEMPERATURE °C	UL 1598A
SXPJ15S	HPS	150	P,C,W,S,T	40	T4	T4	--	90	YES
SXPJ15S	HPS	150	P,C,W,S,T	55	T4	T4	--	90	YES
SXPJ10S	HPS	100	P,C,W,S	40	T4A	T4	T4	90	YES
SXPJ10S	HPS	100	T	40	T4A	T4	--	90	YES
SXPJ10S	HPS	100	P,C,W,S,T	55	T4A	T4	--	90	YES
SXPJ10S	HPS	100	P,C,W,S,T	65	T4A	T4	--	90	YES
SXPJ07S	HPS	70	P,C,W,S	40	T5	T5	T4A	90	YES
SXPJ07S	HPS	70	T	40	T5	T5	--	90	YES
SXPJ07S	HPS	70	P,C,W,S,T	55	T5	T5	--	90	YES
SXPJ07S	HPS	70	P,C,W,S,T	65	T4A	T4	--	90	YES
SXPJ05S	HPS	50	P,C,W,S	40	T5	T5	T4A	90	YES
SXPJ05S	HPS	50	T	40	T5	T5	--	90	YES
SXPJ05S	HPS	50	P,C,W,S,T	55	T5	T5	--	90	YES
SXPJ05S	HPS	50	P,C,W,S,T	65	T4A	T4	--	90	YES
SXPJ17H	PSMH	175	P,C,W,S,T	40	T3C	T3	--	90	YES
SXPJ17H	PSMH	175	P,C,W,S,T	55	T3C	T3	--	90	YES
SXPJ15H	PSMH	150	P,C,W,S,T	40	T3C	T3	--	90	YES
SXPJ15H	PSMH	150	P,C,W,S,T	55	T3C	T3	--	90	YES
SXPJ10H	PSMH	100	P,C,W,S,T	40	T4A	T4	--	90	YES
SXPJ10H	PSMH	100	P,C,W,S,T	55	T4A	T4	--	90	YES
SXPJ10H	PSMH	100	P,C,W,S,T	65	T4	T4	--	90	YES
SXPJ07H	PSMH	70	P,C,W,S	40	T5	T5	T4A	90	YES
SXPJ07H	PSMH	70	T	40	T5	T5	--	90	YES
SXPJ07H	PSMH	70	P,C,W,S,T	55	T4A	T4	--	90	YES
SXPJ07H	PSMH	70	P,C,W,S,T	65	T4A	T4	--	90	YES
SXPJ05H	PSMH	50	P,C,W,S	40	T5	T5	T4A	90	YES
SXPJ05H	PSMH	50	T	40	T5	T5	--	90	YES
SXPJ05H	PSMH	50	P,C,W,S,T	55	T4A	T4	--	90	YES
SXPJ05H	PSMH	50	P,C,W,S,T	65	T4A	T4	--	90	YES
SXPJ03H	PSMH	39	P,C,W,S	40	T5	T5	T4A	90	YES
SXPJ03H	PSMH	39	T	40	T5	T5	--	90	YES
SXPJ03H	PSMH	39	P,C,W,S,T	55	T4A	T4	--	90	YES
SXPJ03H	PSMH	39	P,C,W,S,T	65	T4A	T4	--	90	YES
SXPJ26F	CFL	26	P,C,W	40	T6	T6	T6	90	YES
SXPJ26F	CFL	26	S	40	T5	T5	T5	90	YES
SXPJ26F	CFL	26	T	40	T5	T5	--	90	YES
SXPJ26F	CFL	26	P,C,W	55	T6	T6	--	90	YES
SXPJ26F	CFL	26	S,T	55	T5	T5	--	90	YES
SXPJ32F	CFL	32	P,C,W	40	T6	T6	T6	90	YES
SXPJ32F	CFL	32	S	40	T5	T5	T5	90	YES
SXPJ32F	CFL	32	T	40	T5	T5	--	90	YES
SXPJ32F	CFL	32	P,C,W	55	T6	T6	--	90	YES
SXPJ32F	CFL	32	S,I	55	T5	T5	--	90	YES
SXPJ42F	CFL	42	P,C,W	40	T6	T6	T6	90	YES
SXPJ42F	CFL	42	S	40	T5	T5	T5	90	YES
SXPJ42F	CFL	42	T	40	T5	T5	--	90	YES
SXPJ42F	CFL	42	P,C,W	55	T6	T6	--	90	YES
SXPJ42F	CFL	42	S,T	55	T5	T5	--	90	YES
SXPJ52F	CFL	52	P,C,W	40	T6	T6	T5	90	YES
SXPJ52F	CFL	52	S	40	T5	T5	T5	90	YES
SXPJ52F	CFL	52	T	40	T5	T5	--	90	YES
SXPJ64F	CFL	64	P,C,W	40	T6	T6	T5	90	YES
SXPJ64F	CFL	64	S	40	T5	T5	T5	90	YES
SXPJ64F	CFL	64	T	40	T5	T5	--	90	YES
SXPJ84F	CFL	84	P,C,W	40	T6	T6	T5	90	YES
SXPJ84F	CFL	84	S	40	T5	T5	T5	90	YES
SXPJ84F	CFL	84	I	40	T5	T5	--	90	YES

(*) Medium base

HID • COMPACT FLUORESCENT

SXPJ Series

Explosion Proof • UL 844, &1598A • Marine Outside Type • Factory Sealed

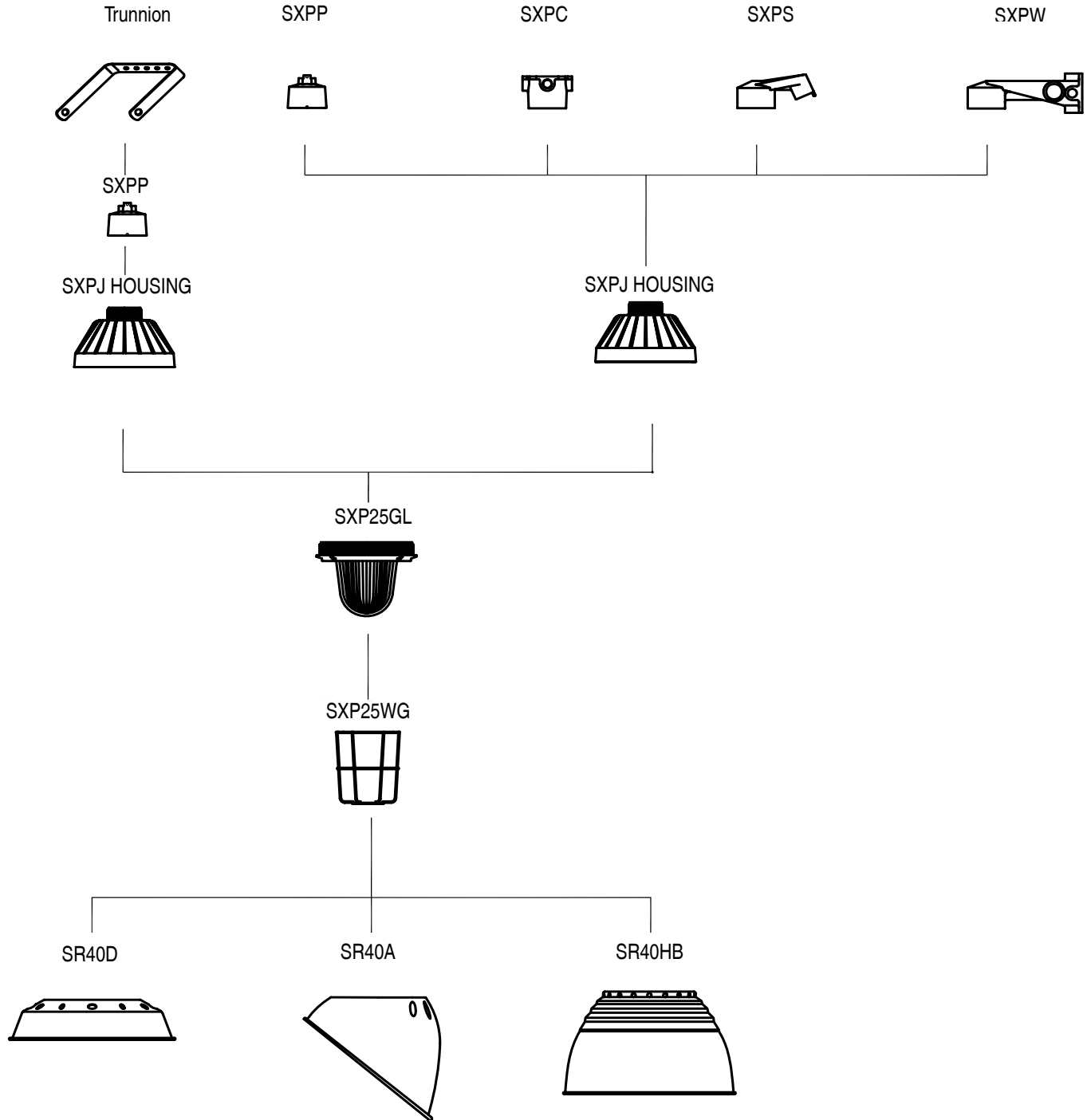





HID • COMPACT FLUORESCENT

SXPJ Series

Explosion Proof • UL 844 & 1598A • Marine Outside Type • Factory Sealed

High Pressure Sodium with Guard 50-150 Watts

(Lamps not included)

Mounting Style	ANSI Lamp Watts	Conduit Lamp Type	Size (In.)	CATALOG NUMBER			Shipping Weight (Lbs.)
				120/208/240/277V	480V 60 HZ	220/240V 50 HZ	
PENDANT 	50	S68	3/4	SXPJ05-S-04-GG-P	SXPJ05-S-48-GG-P	SXPJ05-S-22-GG-P	34.5
	50	S68	1	SXPJ05-S-04-GG-P1	SXPJ05-S-48-GG-P1	SXPJ05-S-22-GG-P1	34.5
	70	S62	3/4	SXPJ07-S-04-GG-P	SXPJ07-S-48-GG-P	SXPJ07-S-22-GG-P	34.5
	70	S62	1	SXPJ07-S-04-GG-P1	SXPJ07-S-48-GG-P1	SXPJ07-S-22-GG-P1	34.5
	100	S54	3/4	SXPJ10-S-04-GG-P	SXPJ10-S-48-GG-P	SXPJ10-S-22-GG-P	37
	100	S54	1	SXPJ10-S-04-GG-P1	SXPJ10-S-48-GG-P1	SXPJ10-S-22-GG-P1	37
	150	S55	3/4	SXPJ15-S-04-GG-P	SXPJ15-S-48-GG-P	SXPJ15-S-22-GG-P	37
	150	S55	1	SXPJ15-S-04-GG-P1	SXPJ15-S-48-GG-P1	SXPJ15-S-22-GG-P1	37
CEILING 	50	S68	3/4	SXPJ05-S-04-GG-C	SXPJ05-S-48-GG-C	SXPJ05-S-22-GG-C	36.5
	50	S68	1	SXPJ05-S-04-GG-C1	SXPJ05-S-48-GG-C1	SXPJ05-S-22-GG-C1	36.5
	70	S62	3/4	SXPJ07-S-04-GG-C	SXPJ07-S-48-GG-C	SXPJ07-S-22-GG-C	36.5
	70	S62	1	SXPJ07-S-04-GG-C1	SXPJ07-S-48-GG-C1	SXPJ07-S-22-GG-C1	36.5
	100	S54	3/4	SXPJ10-S-04-GG-C	SXPJ10-S-48-GG-C	SXPJ10-S-22-GG-C	39
	100	S54	1	SXPJ10-S-04-GG-C1	SXPJ10-S-48-GG-C1	SXPJ10-S-22-GG-C1	39
	150	S55	3/4	SXPJ15-S-04-GG-C	SXPJ15-S-48-GG-C	SXPJ15-S-22-GG-C	39
	150	S55	1	SXPJ15-S-04-GG-C1	SXPJ15-S-48-GG-C1	SXPJ15-S-22-GG-C1	39
WALL 	50	S68	3/4	SXPJ05-S-04-GG-W	SXPJ05-S-48-GG-W	SXPJ05-S-22-GG-W	38.5
	50	S68	1	SXPJ05-S-04-GG-W1	SXPJ05-S-48-GG-W1	SXPJ05-S-22-GG-W1	38.5
	70	S62	3/4	SXPJ07-S-04-GG-W	SXPJ07-S-48-GG-W	SXPJ07-S-22-GG-W	38.5
	70	S62	1	SXPJ07-S-04-GG-W1	SXPJ07-S-48-GG-W1	SXPJ07-S-22-GG-W1	38.5
	100	S54	3/4	SXPJ10-S-04-GG-W	SXPJ10-S-48-GG-W	SXPJ10-S-22-GG-W	41
	100	S54	1	SXPJ10-S-04-GG-W1	SXPJ10-S-48-GG-W1	SXPJ10-S-22-GG-W1	41
	150	S55	3/4	SXPJ15-S-04-GG-W	SXPJ15-S-48-GG-W	SXPJ15-S-22-GG-W	41
	150	S55	1	SXPJ15-S-04-GG-W1	SXPJ15-S-48-GG-W1	SXPJ15-S-22-GG-W1	41
STANCHION ★ 	50	S68	1-1/4	SXPJ05-S-04-GG-S	SXPJ05-S-48-GG-S	SXPJ05-S-22-GG-S	35.5
	50	S68	1-1/2	SXPJ05-S-04-GG-S1	SXPJ05-S-48-GG-S1	SXPJ05-S-22-GG-S1	35.5
	70	S62	1-1/4	SXPJ07-S-04-GG-S	SXPJ07-S-48-GG-S	SXPJ07-S-22-GG-S	35.5
	70	S62	1-1/2	SXPJ07-S-04-GG-S1	SXPJ07-S-48-GG-S1	SXPJ07-S-22-GG-S1	35.5
	100	S54	1-1/4	SXPJ10-S-04-GG-S	SXPJ10-S-48-GG-S	SXPJ10-S-22-GG-S	38
	100	S54	1-1/2	SXPJ10-S-04-GG-S1	SXPJ10-S-48-GG-S1	SXPJ10-S-22-GG-S1	38
	150	S55	1-1/4	SXPJ15-S-04-GG-S	SXPJ15-S-48-GG-S	SXPJ15-S-22-GG-S	38
	150	S55	1-1/2	SXPJ15-S-04-GG-S1	SXPJ15-S-48-GG-S1	SXPJ15-S-22-GG-S1	38
TRUNNION ★ 	50	S68	3/4	SXPJ05-S-04-GG-T	SXPJ05-S-48-GG-T	SXPJ05-S-22-GG-T	37.5
	70	S62	3/4	SXPJ07-S-04-GG-T	SXPJ07-S-48-GG-T	SXPJ07-S-22-GG-T	37.5
	100	S54	3/4	SXPJ10-S-04-GG-T	SXPJ10-S-48-GG-T	SXPJ10-S-22-GG-T	40
	150	S55	3/4	SXPJ15-S-04-GG-T	SXPJ15-S-48-GG-T	SXPJ15-S-22-GG-T	40

★ Refer to Certification Guide to determine suitability of individual fixture.





HID • COMPACT FLUORESCENT

SXPJ Series

Explosion Proof • UL 844, & 1598A • Marine Outside Type • Factory Sealed

Metal Halide with Guard 50-175 Watts

(Lamps not included)

Mounting Style	ANSI Lamp Watts	Conduit Lamp Type	Size (In.)	CATALOG NUMBER			Shipping Weight (Lbs.)
				120/208/240/277V	480V 60 HZ	220/240V 50 HZ	
 <p>PENDANT</p>	50	M110	3/4	SXPJ05-H-04-GG-P	SXPJ05-H-48-GG-P	SXPJ05-H-22-GG-P	34.5
	50	M110	1	SXPJ05-H-04-GG-P1	SXPJ05-H-48-GG-P1	SXPJ05-H-22-GG-P1	34.5
	70	M98	3/4	SXPJ07-H-04-GG-P	SXPJ07-H-48-GG-P	SXPJ07-H-22-GG-P	34.5
	70	M98	1	SXPJ07-H-04-GG-P1	SXPJ07-H-48-GG-P1	SXPJ07-H-22-GG-P1	34.5
	100	M90	3/4	SXPJ10-H-04-GG-P	SXPJ10-H-48-GG-P	SXPJ10-H-22-GG-P	37
	100	M90	1	SXPJ10-H-04-GG-P1	SXPJ10-H-48-GG-P1	SXPJ10-H-22-GG-P1	37
	150	M102	3/4	SXPJ15-H-04-GG-P	SXPJ15-H-48-GG-P	SXPJ15-H-22-GG-P	37
	150	M102	1	SXPJ15-H-04-GG-P1	SXPJ15-H-48-GG-P1	SXPJ15-H-22-GG-P1	37
	175	M137/M152	3/4	SXPJ17-H-04-GG-P	SXPJ17-H-48-GG-P	SXPJ17-H-22-GG-P	41
	175	M137/M152	1	SXPJ17-H-04-GG-P1	SXPJ17-H-48-GG-P1	SXPJ17-H-22-GG-P1	41
 <p>CEILING</p>	50	M110	3/4	SXPJ05-H-04-GG-C	SXPJ05-H-48-GG-C	SXPJ05-H-22-GG-C	36.5
	50	M110	1	SXPJ05-H-04-GG-C1	SXPJ05-H-48-GG-C1	SXPJ05-H-22-GG-C1	36.5
	70	M98	3/4	SXPJ07-H-04-GG-C	SXPJ07-H-48-GG-C	SXPJ07-H-22-GG-C	36.5
	70	M98	1	SXPJ07-H-04-GG-C1	SXPJ07-H-48-GG-C1	SXPJ07-H-22-GG-C1	36.5
	100	M90	3/4	SXPJ10-H-04-GG-C	SXPJ10-H-48-GG-C	SXPJ10-H-22-GG-C	39
	100	M90	1	SXPJ10-H-04-GG-C1	SXPJ10-H-48-GG-C1	SXPJ10-H-22-GG-C1	39
	150	M102	3/4	SXPJ15-H-04-GG-C	SXPJ15-H-48-GG-C	SXPJ15-H-22-GG-C	39
	150	M102	1	SXPJ15-H-04-GG-C1	SXPJ15-H-48-GG-C1	SXPJ15-H-22-GG-C1	39
	175	M137/M152	3/4	SXPJ17-H-04-GG-C	SXPJ17-H-48-GG-C	SXPJ17-H-22-GG-C	43
	175	M137/M152	1	SXPJ17-H-04-GG-C1	SXPJ17-H-48-GG-C1	SXPJ17-H-22-GG-C1	43
 <p>WALL</p>	50	M110	3/4	SXPJ05-H-04-GG-W	SXPJ05-H-48-GG-W	SXPJ05-H-22-GG-W	38.5
	50	M110	1	SXPJ05-H-04-GG-W1	SXPJ05-H-48-GG-W1	SXPJ05-H-22-GG-W1	38.5
	70	M98	3/4	SXPJ07-H-04-GG-W	SXPJ07-H-48-GG-W	SXPJ07-H-22-GG-W	38.5
	70	M98	1	SXPJ07-H-04-GG-W1	SXPJ07-H-48-GG-W1	SXPJ07-H-22-GG-W1	38.5
	100	M90	3/4	SXPJ10-H-04-GG-W	SXPJ10-H-48-GG-W	SXPJ10-H-22-GG-W	41
	100	M90	1	SXPJ10-H-04-GG-W1	SXPJ10-H-48-GG-W1	SXPJ10-H-22-GG-W1	41
	150	M102	3/4	SXPJ15-H-04-GG-W	SXPJ15-H-48-GG-W	SXPJ15-H-22-GG-W	41
	150	M102	1	SXPJ15-H-04-GG-W1	SXPJ15-H-48-GG-W1	SXPJ15-H-22-GG-W1	41
	175	M137/M152	3/4	SXPJ17-H-04-GG-W	SXPJ17-H-48-GG-W	SXPJ17-H-22-GG-W	45
	175	M137/M152	1	SXPJ17-H-04-GG-W1	SXPJ17-H-48-GG-W1	SXPJ17-H-22-GG-W1	45
 <p>STANCHION ★</p>	50	M110	1-1/4	SXPJ05-H-04-GG-S	SXPJ05-H-48-GG-S	SXPJ05-H-22-GG-S	35.5
	50	M110	1-1/2	SXPJ05-H-04-GG-S1	SXPJ05-H-48-GG-S1	SXPJ05-H-22-GG-S1	35.5
	70	M98	1-1/4	SXPJ07-H-04-GG-S	SXPJ07-H-48-GG-S	SXPJ07-H-22-GG-S	35.5
	70	M98	1-1/2	SXPJ07-H-04-GG-S1	SXPJ07-H-48-GG-S1	SXPJ07-H-22-GG-S1	35.5
	100	M90	1-1/4	SXPJ10-H-04-GG-S	SXPJ10-H-48-GG-S	SXPJ10-H-22-GG-S	38
	100	M90	1-1/2	SXPJ10-H-04-GG-S1	SXPJ10HS-48-GG-S1	SXPJ10-H-22-GG-S1	38
	150	M102	1-1/4	SXPJ15-H-04-GG-S	SXPJ15-H-48-GG-S	SXPJ15-H-22-GG-S	38
	150	M102	1-1/2	SXPJ15-H-04-GG-S1	SXPJ15-H-48-GG-S1	SXPJ15-H-22-GG-S1	38
	175	M137/M152	1-1/4	SXPJ17-H-04-GG-S	SXPJ17-H-48-GG-S	SXPJ17-H-22-GG-S	42
	175	M137/M152	1-1/2	SXPJ17-H-04-GG-S1	SXPJ17-H-48-GG-S1	SXPJ17-H-22-GG-S1	42
 <p>TRUNNION ★</p>	50	M110	3/4	SXPJ05-H-04-GG-T	SXPJ05-H-48-GG-T	SXPJ05-H-22-GG-T	37.5
	70	M98	3/4	SXPJ07-H-04-GG-T	SXPJ07-H-48-GG-T	SXPJ07-H-22-GG-T	37.5
	100	M90	3/4	SXPJ10-H-04-GG-T	SXPJ10-H-48-GG-T	SXPJ10-H-22-GG-T	40
	150	M102	3/4	SXPJ15-H-04-GG-T	SXPJ15-H-48-GG-T	SXPJ15-H-22-GG-T	40
	175	M137/M152	3/4	SXPJ17-H-04-GG-T	SXPJ17-H-48-GG-T	SXPJ17-H-22-GG-T	42

★ Refer to Certification Guide to determine suitability of individual fixture.

HID • COMPACT FLUORESCENT

SXPJ Series

Explosion Proof • UL 844 & 1598A • Marine Outside Type • Factory Sealed

SXPJ Fixture Dimensions (inches)

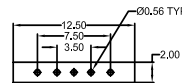
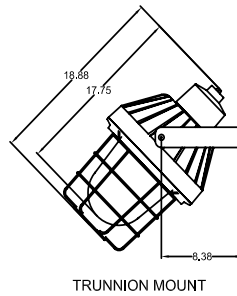
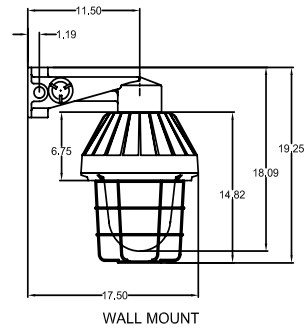
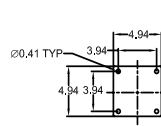
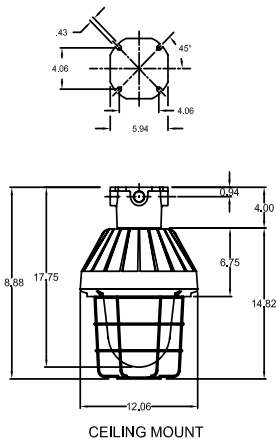
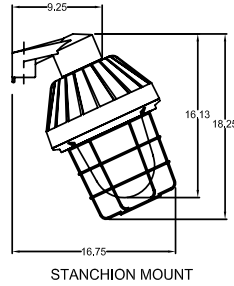
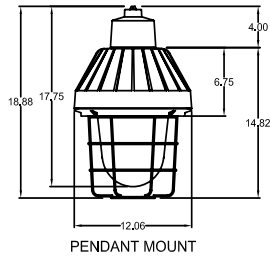

REFLECTORS

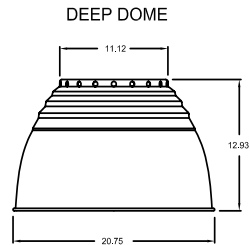
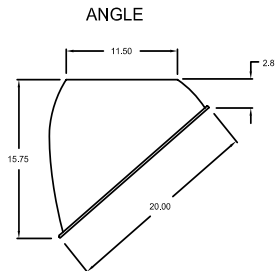
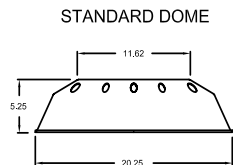

HID • COMPACT FLUORESCENT

SXPJ Series

Explosion Proof • UL 844, & 1598A • Marine Outside Type • Factory Sealed

Coefficients of Utilization

SXPJ17-HD-XX

% Effective Ceiling Cavity Reflectance rcc	80			50			10		
% Wall Reflectance rw	50	30	10	50	30	10	50	30	10
Room Cavity Ratio RCR	Effective Floor Cavity Reflectance 20%								
0	.92	.92	.92	.86	.86	.86	.78	.78	.78
1	.79	.75	.71	.73	.70	.67	.66	.65	.63
2	.67	.61	.56	.62	.57	.53	.57	.53	.50
3	.57	.50	.45	.53	.48	.43	.49	.45	.41
4	.50	.42	.37	.47	.40	.36	.43	.38	.34
5	.44	.36	.31	.41	.35	.30	.38	.33	.29
6	.39	.32	.26	.37	.30	.26	.34	.29	.25
7	.35	.28	.23	.33	.27	.22	.31	.26	.22
8	.32	.25	.20	.30	.24	.20	.28	.23	.19
9	.29	.22	.18	.28	.22	.18	.26	.21	.17
10	.27	.20	.16	.25	.20	.16	.24	.19	.15

Candlepower Distribution

Deg.	Parl.
5	2466
15	2507
25	2456
35	2389
45	2307
55	2112
65	1917
75	1210
85	251
90	56

Photometric Data

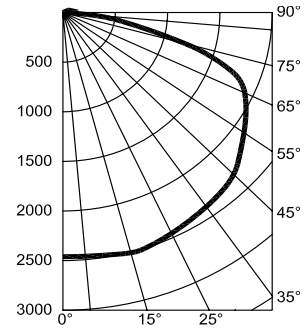





HID • COMPACT FLUORESCENT

SXPJ Series

Explosion Proof • UL 844 & 1598A • Marine Outside Type • Factory Sealed

Compact Fluorescent with Guard 26, 32 & 42 Watts

(Lamps included)

Mounting Style	Lamp Watts	Lamp Base	Conduit Size (In.)	120 thru 277V 50/60 HZ		Shipping Weight (Lbs.)
				Emergency & Normal	Emergency Only	
PENDANT 	26	GX24Q-3	3/4	SXPJ26-F-U-GG-P-EM	SXPJ26-F-U-GG-P-EMO	38.5
	26	GX24Q-3	1	SXPJ26-F-U-GG-P1-EM	SXPJ26-F-U-GG-P1-EMO	38.5
	32	GX24Q-3	3/4	SXPJ32-F-U-GG-P-EM	SXPJ32-F-U-GG-P-EMO	38.5
	32	GX24Q-3	1	SXPJ32-F-U-GG-P1-EM	SXPJ32-F-U-GG-P1-EMO	38.5
	42	GX24Q-4	3/4	SXPJ42-F-U-GG-P-EM	SXPJ42-F-U-GG-P-EMO	38.5
	42	GX24Q-4	1	SXPJ42-F-U-GG-P1-EM	SXPJ42-F-U-GG-P1-EMO	38.5
CEILING 	26	GX24Q-3	3/4	SXPJ26-F-U-GG-C-EM	SXPJ26-F-U-GG-C-EMO	40.5
	26	GX24Q-3	1	SXPJ26-F-U-GG-C1-EM	SXPJ26-F-U-GG-C1-EMO	40.5
	32	GX24Q-3	3/4	SXPJ32-F-U-GG-C-EM	SXPJ32-F-U-GG-C-EMO	40.5
	32	GX24Q-3	1	SXPJ32-F-U-GG-C1-EM	SXPJ32-F-U-GG-C1-EMO	40.5
	42	GX24Q-4	3/4	SXPJ42-F-U-GG-C-EM	SXPJ42-F-U-GG-C-EMO	40.5
	42	GX24Q-4	1	SXPJ42-F-U-GG-C1-EM	SXPJ42-F-U-GG-C1-EMO	40.5
WALL 	26	GX24Q-3	3/4	SXPJ26-F-U-GG-W-EM	SXPJ26-F-U-GG-W-EMO	42.5
	26	GX24Q-3	1	SXPJ26-F-U-GG-W1-EM	SXPJ26-F-U-GG-W1-EMO	42.5
	32	GX24Q-3	3/4	SXPJ32-F-U-GG-W-EM	SXPJ32-F-U-GG-W-EMO	42.5
	32	GX24Q-3	1	SXPJ32-F-U-GG-W1-EM	SXPJ32-F-U-GG-W1-EMO	42.5
	42	GX24Q-4	3/4	SXPJ42-F-U-GG-W-EM	SXPJ42-F-U-GG-W-EMO	42.5
	42	GX24Q-4	1	SXPJ42-F-U-GG-W1-EM	SXPJ42-F-U-GG-W1-EMO	42.5
STANCHION ★ 	26	GX24Q-3	1-1/4	SXPJ26-F-U-GG-S-EM	SXPJ26-F-U-GG-S-EMO	39.5
	26	GX24Q-3	1-1/2	SXPJ26-F-U-GG-S1-EM	SXPJ26-F-U-GG-S1-EMO	39.5
	32	GX24Q-3	1-1/4	SXPJ32-F-U-GG-S-EM	SXPJ32-F-U-GG-S-EMO	39.5
	32	GX24Q-3	1-1/2	SXPJ32-F-U-GG-S1-EM	SXPJ32-F-U-GG-S1-EMO	39.5
	42	GXQ24-4	1-1/4	SXPJ42-F-U-GG-S-EM	SXPJ42-F-U-GG-S-EMO	39.5
	42	GXQ24-4	1-1/2	SXPJ42-F-U-GG-S1-EM	SXPJ42-F-U-GG-S1-EMO	39.5
TRUNNION ★ 	26	GX24Q-3	3/4	SXPJ26-F-U-GG-T-EM	SXPJ26-F-U-GG-T-EMO	41.5
	32	GX24Q-3	3/4	SXPJ32-F-U-GG-T-EM	SXPJ32-F-U-GG-T-EMO	41.5
	42	GX24Q-4	3/4	SXPJ42-F-U-GG-T-EM	SXPJ42-F-U-GG-T-EMO	41.5

★ Refer to Certification Guide to determine suitability of individual fixture.

HID • COMPACT FLUORESCENT

SXPJ Series

Explosion Proof • UL 844, &1598A • Marine Outside Type • Factory Sealed

Compact Fluorescent with Guard 52, 64 & 84 Watts

(Lamps included)

Mounting Style	Lamp Watts	Lamp Base	Conduit Size (In.)	120 thru 277V 50/60 HZ		Shipping Weight (Lbs.)
				Emergency & Normal	Emergency Only	
PENDANT 	52	GX24Q-3	3/4	SXPJ52-F-U-GG-P-EM SXPJ52-F-U-GG-P1-EM	SXPJ52-F-U-GG-P-EMO SXPJ52-F-U-GG-P1-EMO	38.5
	52	GX24Q-3	1			38.5
	64	GX24Q-3	3/4	SXPJ64-F-U-GG-P-EM SXPJ64-F-U-GG-P1-EM		38.5
	64	GX24Q-3	1			38.5
	84	GX24Q-4	3/4	SXPJ84-F-U-GG-P-EM SXPJ84-F-U-GG-P1-EM		38.5
	84	GX24Q-4	1			38.5
CEILING 	52	GX24Q-3	3/4	SXPJ52-F-U-GG-C-EM SXPJ52-F-U-GG-C1-EM	SXPJ52-F-U-GG-C-EMO SXPJ52-F-U-GG-C1-EMO	40.5
	52	GX24Q-3	1			40.5
	64	GX24Q-3	3/4	SXPJ64-F-U-GG-C-EM SXPJ64-F-U-GG-C1-EM		40.5
	64	GX24Q-3	1			40.5
	84	GX24Q-4	3/4	SXPJ84-F-U-GG-C-EM SXPJ84-F-U-GG-C1-EM		40.5
	84	GX24Q-4	1			40.5
WALL 	52	GX24Q-3	3/4	SXPJ52-F-U-GG-W-EM SXPJ52-F-U-GG-W1-EM	SXPJ52-F-U-GG-W-EMO SXPJ52-F-U-GG-W1-EMO	42.5
	52	GX24Q-3	1			42.5
	64	GX24Q-3	3/4	SXPJ64-F-U-GG-W-EM SXPJ64-F-U-GG-W1-EM		42.5
	64	GX24Q-3	1			42.5
	84	GX24Q-4	3/4	SXPJ84-F-U-GG-W-EM SXPJ84-F-U-GG-W1-EM		42.5
	84	GX24Q-4	1			42.5
STANCHION ★ 	52	GX24Q-3	1-1/4	SXPJ52-F-U-GG-S-EM SXPJ52-F-U-GG-S1-EM	SXPJ52-F-U-GG-S-EMO SXPJ52-F-U-GG-S1-EMO	39.5
	52	GX24Q-3	1-1/2			39.5
	64	GX24Q-3	1-1/4	SXPJ64-F-U-GG-S-EM SXPJ64-F-U-GG-S1-EM		39.5
	64	GX24Q-3	1-1/2			39.5
	42	GXQ24-4	1-1/4	SXPJ84-F-U-GG-S-EM SXPJ84-F-U-GG-S1-EM		39.5
	42	GXQ24-4	1-1/2			39.5
TRUNNION ★ 	26	GX24Q-3	3/4	SXPJ52-F-U-GG-T-EM	SXPJ52-F-U-GG-T-EMO	41.5
	32	GX24Q-3	3/4	SXPJ64-F-U-GG-T-EM		41.5
	42	GX24Q-4	3/4	SXPJ84-F-U-GG-T-EM		41.5





★ Refer to Certification Guide to determine suitability of individual fixture.



HID • COMPACT FLUORESCENT



SXPJ Series



Explosion Proof • UL 844 & 1598A • Marine Outside Type • Factory Sealed

Components and Accessories

Outlet Boxes	Description	Hub Size (In.)	Catalog Number	Shipping Weight (Lbs.)
	Pendant	3/4 1	SXPP SXPP1	2.15 2.15
	Ceiling	3/4 1	SXPC SXPC1	4.0 4.0
	Wall	3/4 1	SXPW SXPW1	6.20 6.20
	Stanchion	1-1/4 1-1/2	SXPS SXPS1	3.20 3.20

Globes and Guards	Description	Catalog Number	Shipping Weight (Lbs.)
	Prismatic Glass Globe Assembly for 70-150W HPS, 175-250W MH & LED	SXP25GL	6.50
	Stainless Steel Wire Guard for 70-150W HPS, 175-250W MH & LED	SXP25WG	1.50

Reflectors	Description	Catalog Number	Shipping Weight (Lbs.)
	Standard Dome Reflector Fiberglass Filled Polymeric	SR40D	3.00
	30° Angle Reflector Fiberglass Filled Polymeric	SR40A	4.50
	High Bay Aluminum Reflector with Baked on White Enamel	SR40HB	5.00

Connector Blocks And Sockets	Description	Catalog Number	Shipping Weight (Lbs.)
	Replacement Female Connector Block (for outlet boxes 50-400 W)	26641	1.00
	Replacement Socket 50-175 W Medium Base	70060	1.50

SXPJ Floodlight Series

Explosion Proof • UL 844, & 1598A • Marine Outside Type • Factory Sealed

Catalog Number Logic

SXPJ-15-S-04-GG-T-XX

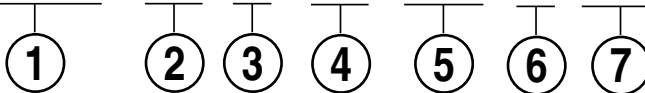

1 BASIC SERIES
 Class I, Division 1, Groups C & D
 Class II, Division 1, Groups E, F & G*
 Class III
 Class I, Zone 1, Groups IIA & IIB
 Factory Sealed
 UL 1598, UL1598A, & UL 844
 CUL
 NEMA Type 4X, IP66

2 LAMP CURRENT/LAMP WATTAGE
 26 = 26 Watt
 32 = 32 Watt
 42 = 42 Watt
 52 = 52 Watt
 64 = 64 Watt
 84 = 84 Watt
 05 = 50 Watt
 07 = 70 Watt
 10 = 100 Watt
 15 = 150 Watt
 17 = 175 Watt

3 LAMP TYPE
 H = Metal Halide (Medium Base)
 (50, 70, 100, 150 & 175 Watt)
 S = High Pressure Sodium (Medium Base)
 (50, 70, 100 & 150 Watt)
 F = Compact Fluorescent
 (26, 32, 42, 52, 64 & 84 Watt)

4 BALLAST VOLTAGE
 04 = 120/208/240/277V 60 HZ
 22 = 220V/240V 50 HZ
 48 = 480V 60 HZ
 U = 120 thru 277V 50/60 HZ
 (compact fluorescent)

5 GLOBE & GUARD
 GG = Globe and Guard
 G = Globe only

6 MOUNTING STYLE
 T = Trunnion Mount*

OPTIONS¹
 FB1 = Single Fuse Block ^{2 3}
 FB2 = Double Fuse Block ^{2 3}
 EM = Emergency Battery Backup⁴
 w/ AC Ballast (CFL Only)
 EMO = Emergency Only Battery

7
 Backup w/o AC Ballast
 (CFL Only)
 PS = Pulse Start (for 150 & 175W MH Lamps)
 BP = Ballast Protector
 SC = Safety Cable & Eye Bolt
 EB = Eye Bolt Only

¹ Consult factory for pricing.

² Not available with multi-tap ballast unless voltage is specified. When installed, one fuse block is provided for 120,277V and two fuse blocks are provided for 208, 220, 240 & 480V. Fuse provided

³ Fuse option not available for marine listed fixtures.

⁴ For non-switched circuits only.

* Trunnion mount not approved for use in Class II environments

Catalog logic is for explaining catalog number structure only. Not all combinations are possible; consult factory for catalog numbers not listed in charts.

HID • COMPACT FLUORESCENT

SXPJ Floodlight Series

Explosion Proof • UL 844 & 1598A • Marine Outside Type • Factory Sealed

Certification Guide

MODEL	TYPE (*)	LAMP WATTS	MOUNT	AMBIENT TEMPERATURE °C	CLASS I DIVISION 1 GROUPS C & D	SUPPLY WIRE SUITABLE TEMPERATURE °C	UL 1598A
SXP40S	HPS	400	T	40	T3A	90	YES
SXP25S	HPS	250	T	40	T3C	90	YES
SXP25S	HPS	250	T	55	T3C	90	YES
SXP15S	HPS	150	T	40	T4	90	YES
SXP15S	HPS	150	T	55	T4	90	YES
SXP15S	HPS	150	T	65	T3C	90	YES
SXP10S	HPS	100	T	40	T4A	90	YES
SXP10S	HPS	100	T	55	T4A	90	YES
SXP10S	HPS	100	T	65	T4	90	YES
SXP07S	HPS	70	T	40	T4A	90	YES
SXP07S	HPS	70	T	55	T4A	90	YES
SXP07S	HPS	70	T	65	T4	90	YES
SXP40H	PSMH	400	T	40	T3A	90	YES
SXP35H	PSMH	350	T	40	T3A	90	YES
SXP32H	PSMH	320	T	40	T3A	90	YES
SXP25H	PSMH	250	T	40	T3C	90	YES
SXP25H	PSMH	250	T	55	T3A	90	YES
SXP17H	PSMH	175	T	40	T4	90	YES
SXP17H	PSMH	175	T	55	T3C	90	YES
SXP17H	PSMH	175	T	65	T3C	90	YES
SXP15H	PSMH	150	T	40	T4	90	YES
SXP15H	PSMH	150	T	55	T3C	90	YES
SXP15H	PSMH	150	T	65	T3C	90	YES



(*) Mogul Base

HID • COMPACT FLUORESCENT

SXPJ Floodlight Series

Explosion Proof • UL 844, &1598A • Marine Outside Type • Factory Sealed

(Lamps included)

Lamp Type	Lamp Watts	ANSI Lamp Type	Conduit Size (In.)	CATALOG NUMBER			Shipping Weight (Lbs.)
				120/208/240/277	480V 60 HZ	220V 50 HZ	
HIGH PRESSURE SODIUM 	50	S68	3/4	SXPJ50-S-04-GG-T	SXPJ07-S-48-GG-T	SXPJ07-S-22-GG-T	37.5
	70	S62	3/4	SXPJ07-S-04-GG-T	SXPJ10-S-48-GG-T	SXPJ10-S-22-GG-T	37.5
	100	S54	3/4	SXPJ10-S-04-GG-T	SXPJ15-S-48-GG-T	SXPJ15-S-22-GG-T	40
	150	S55	3/4	SXPJ15-S-04-GG-T	SXPJ25-S-48-GG-T	SXPJ25-S-22-GG-T	40
METAL HALIDE 	50	M110	3/4	SXPJ50-H-04-GG-T	SXPJ50-H-48-GG-T-PS	SXPJ50-H-22-GG-T-PS	37.5
	70	M98	3/4	SXPJ07-H-04-GG-T	SXPJ07-H-48-GG-T-PS	SXPJ07-H-22-GG-T-PS	37.5
	100	M90	3/4	SXPJ10-H-04-GG-T-PS	SXPJ10-H-48-GG-T-PS	SXPJ10-H-22-GG-T-PS	40
	150	M102	3/4	SXPJ15-H-04-GG-T-PS	SXPJ15-H-48-GG-T-PS	SXPJ15-H-22-GG-T-PS	40
	175	M152	3/4	SXPJ17-H-04-GG-T-PS	SXPJ17-H-48-GG-T-PS	SXPJ17-H-22-GG-T-PS	43.5
FLUORESCENT 	26	GX24Q3	3/4	SXPJ26-F-U-GG-T			41.5
	32	GX24Q3	3/4	SXPJ32-F-U-GG-T			41.5
	42	GX24Q4	3/4	SXPJ42-F-U-GG-T			41.5
	52	GX24Q3	3/4	SXPJ52-F-U-GG-T			41.5
	64	GX24Q3	3/4	SXPJ64-F-U-GG-T			41.5
	84	GX24Q4	3/4	SXPJ84-F-U-GG-T			41.5



HID • COMPACT FLUORESCENT



SXPJ Floodlight Series



Explosion Proof • UL 844 & 1598A • Marine Outside Type • Factory Sealed

Components and Accessories

Outlet Boxes	Description	Hub Size (In.)	Catalog Number	Shipping Weight (Lbs.)
	Pendant	3/4 1	SXPP SXPP1	2.15 2.15

Reflectors	Description	Catalog Number	Shipping Weight (Lbs.)
	Standard Dome Reflector Fiberglass Filled Polymeric	SR40D	3.00
	30° Angle Reflector Fiberglass Filled Polymeric	SR40A	4.50
	High Bay Aluminum Reflector with Baked on White Enamel	SR40HB	5.00

Globes and Guards	Description	Catalog Number	Shipping Weight (Lbs.)
	Prismatic Glass Globe Assembly for 70-150W HPS, 175-250W MH & LED	SXP25GL	6.50
	Stainless Steel Wire Guard for 70-150W HPS, 175-250W MH & LED	SXP25WG	1.50

Connector Blocks And Sockets	Description	Catalog Number	Shipping Weight (Lbs.)
	Replacement Female Connector Block (for outlet boxes 50-400W)	26641	1.00
	Replacement Socket 50-175W Medium Base	70060	1.50